

BS036 Installation Instruction

Please be sure to use a manual screwdriver and refrain from using an electric drill.

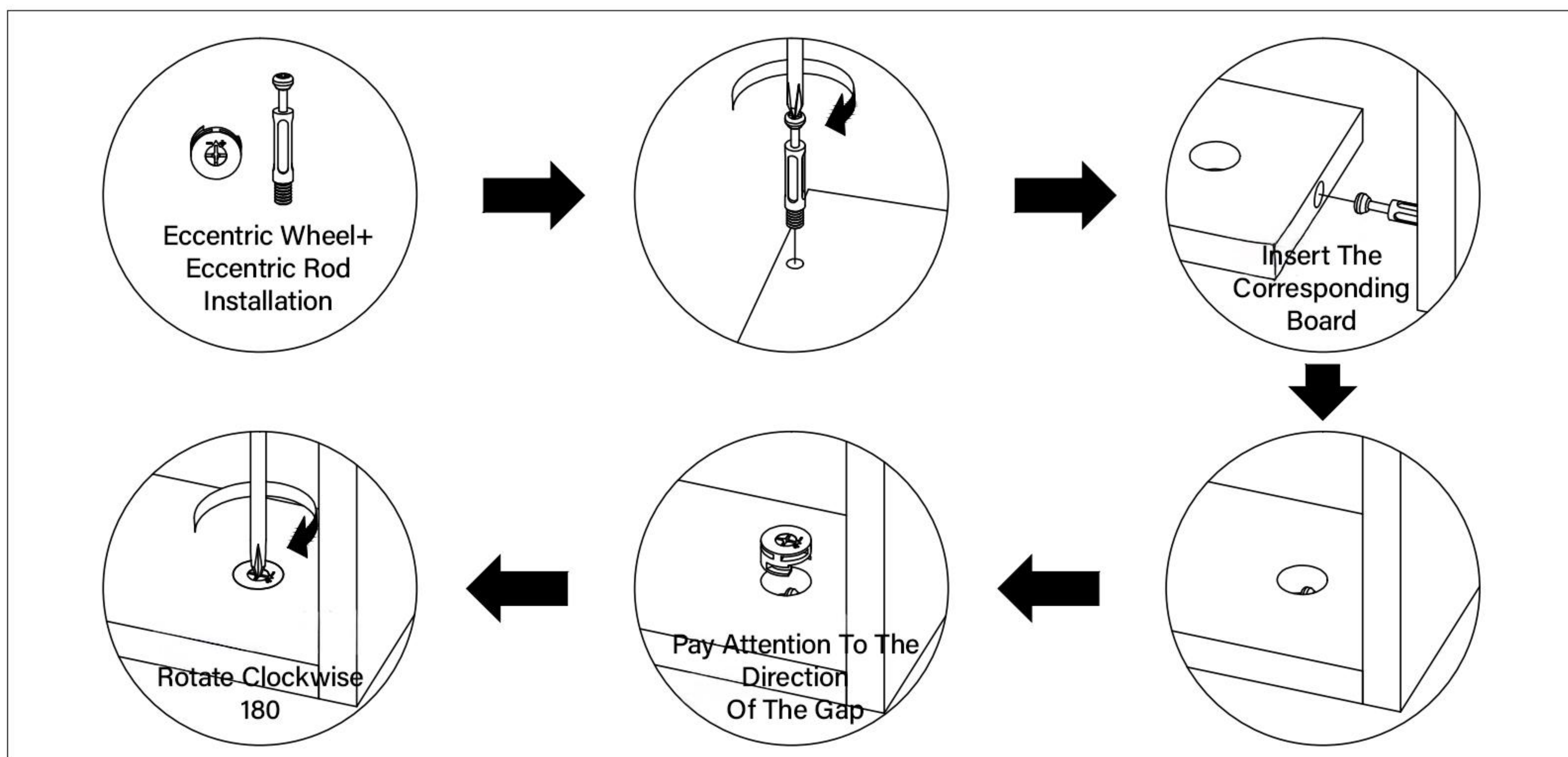
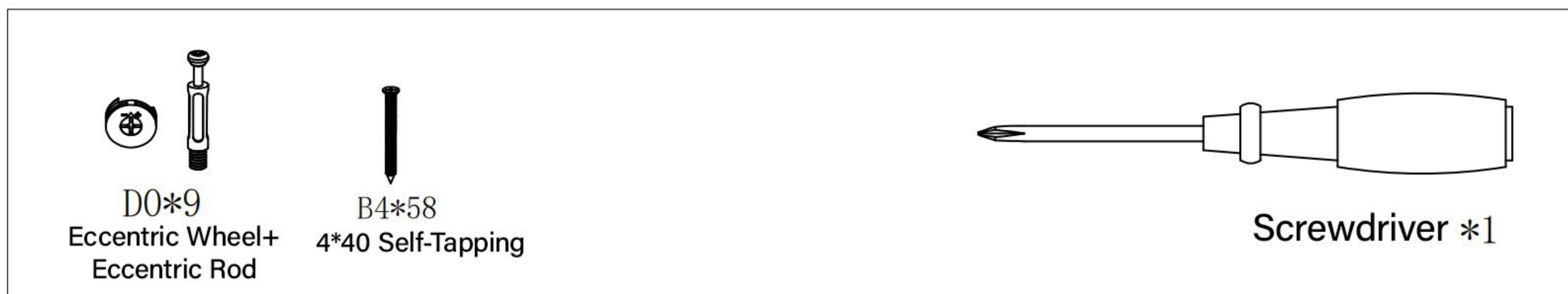
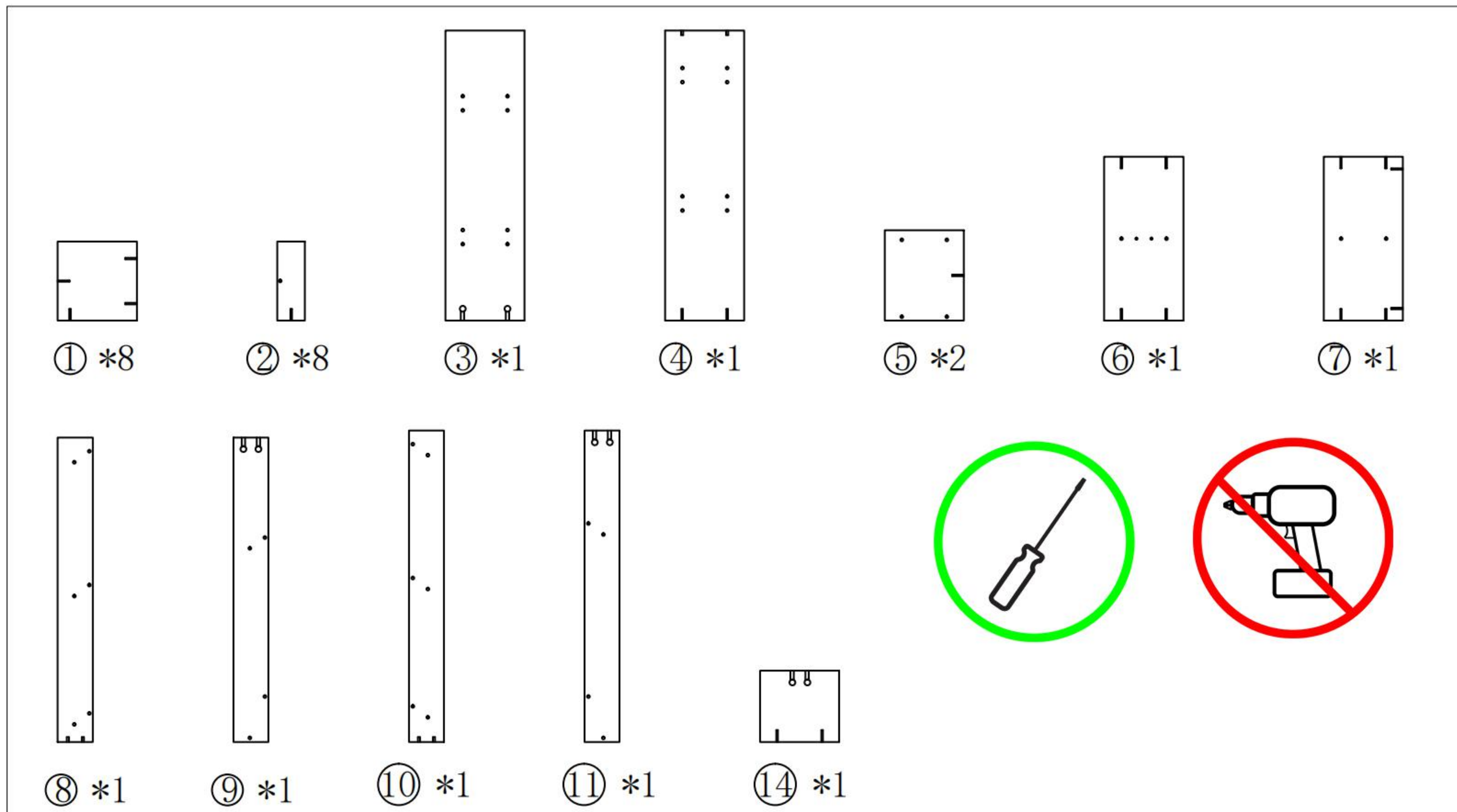

1,

Pay Attention To The Small Holes Circled On The Sides Of Plates No. 8, 9, 10 And 11.

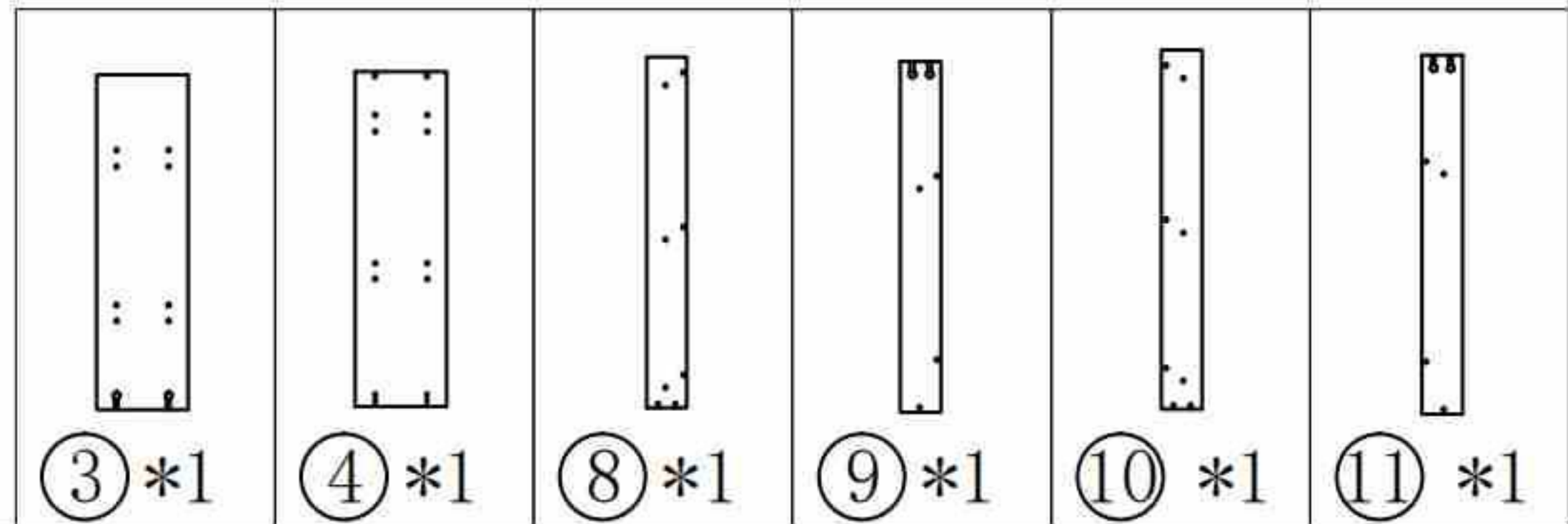
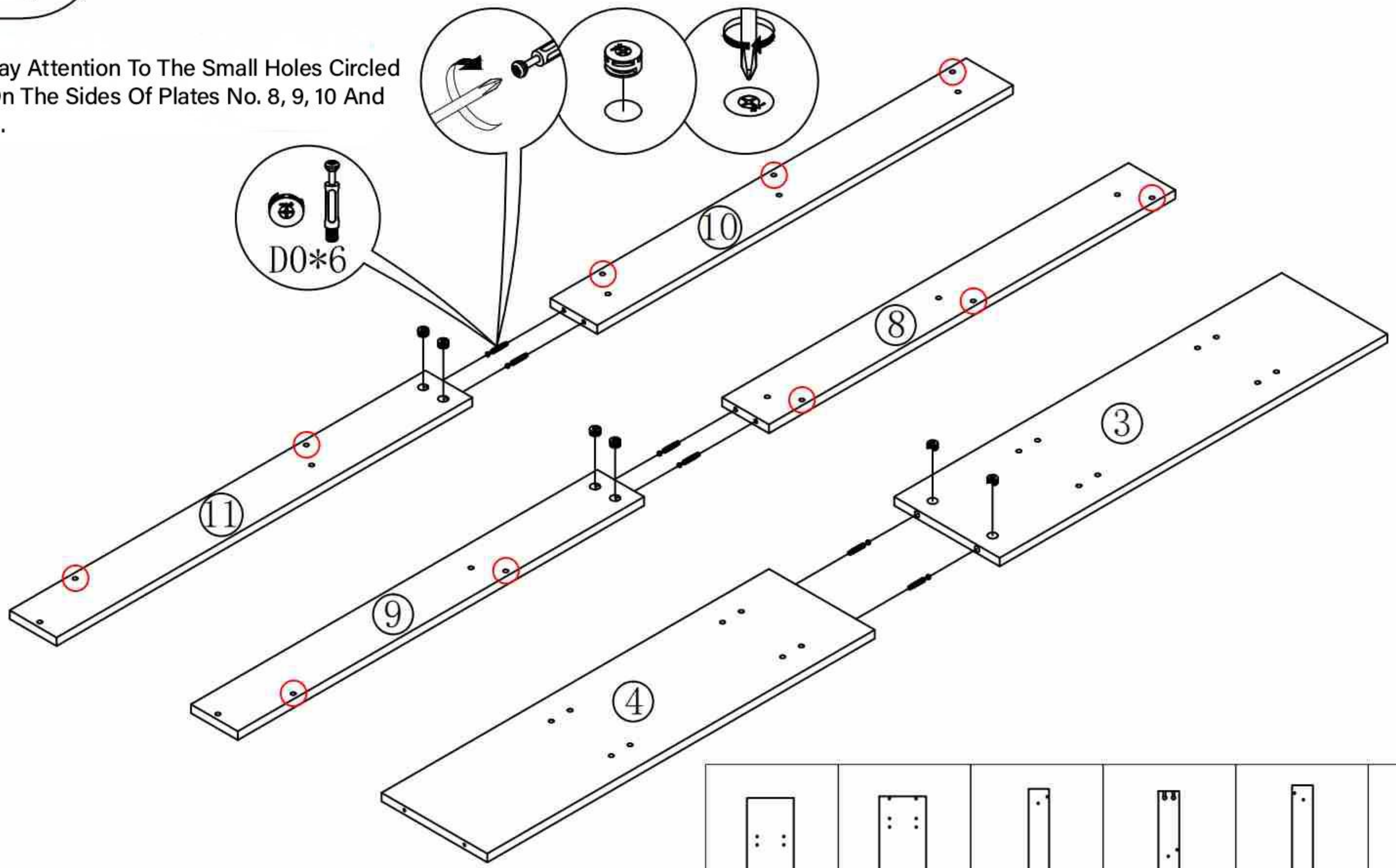

2,

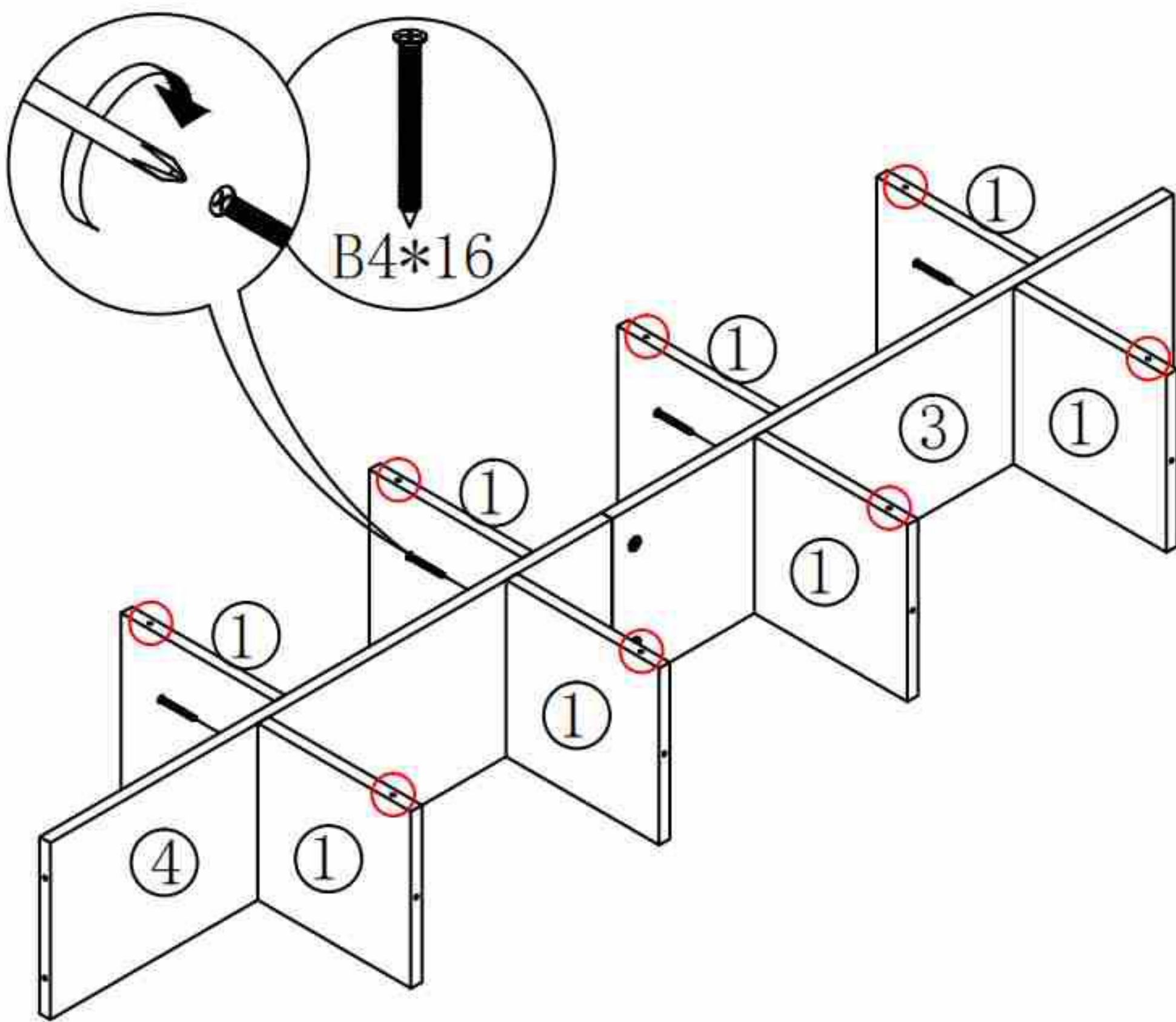

Pay Attention To The Location Of The Small Holes Circled

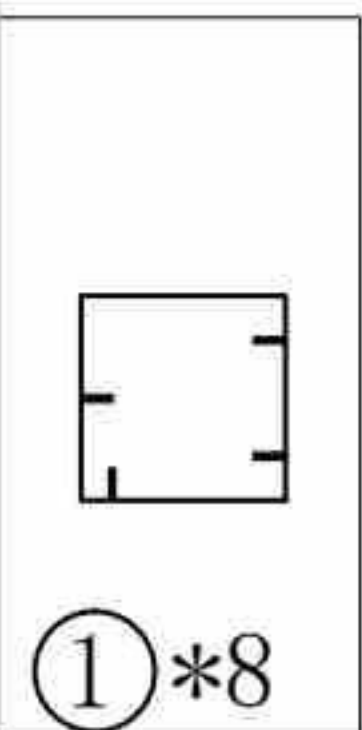

3,

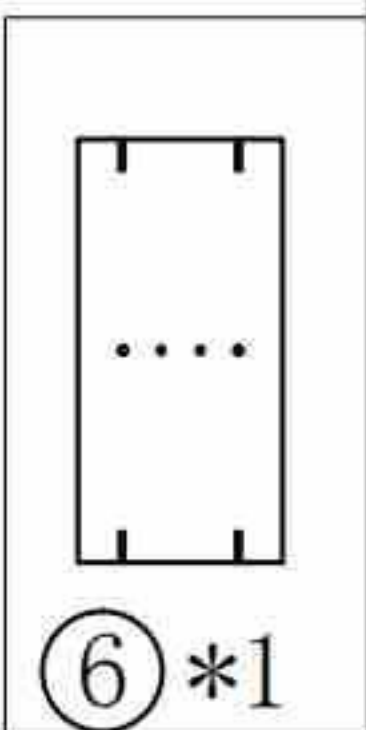
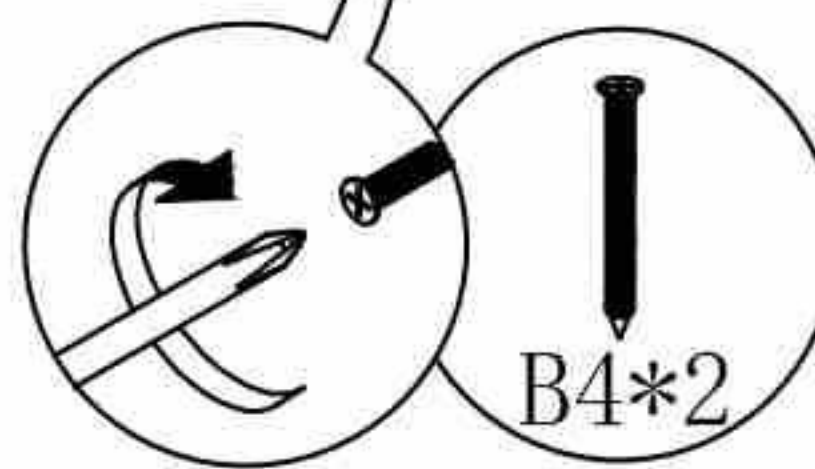
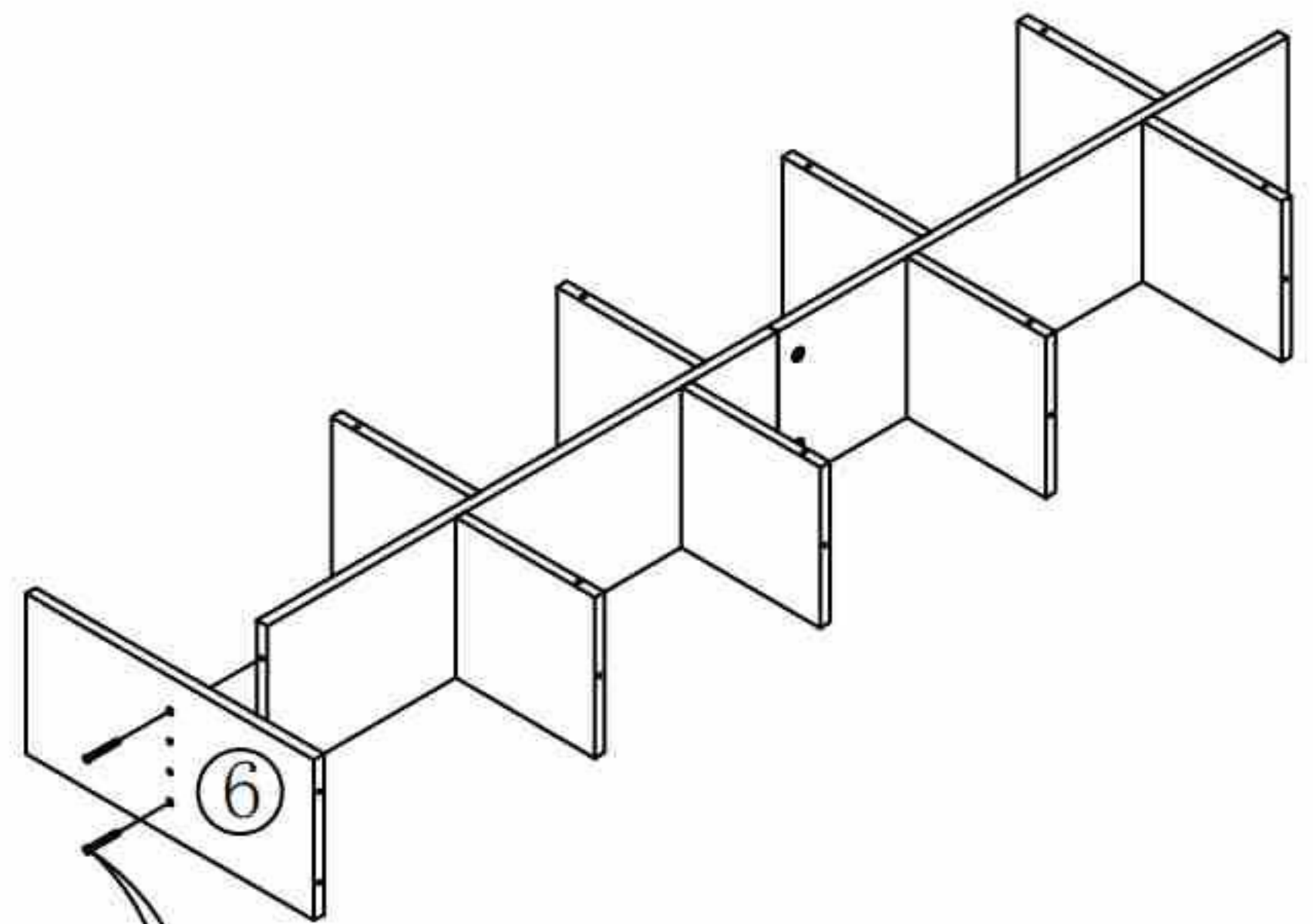

4,

Pay Attention To Circle The Location Of The Small Hole

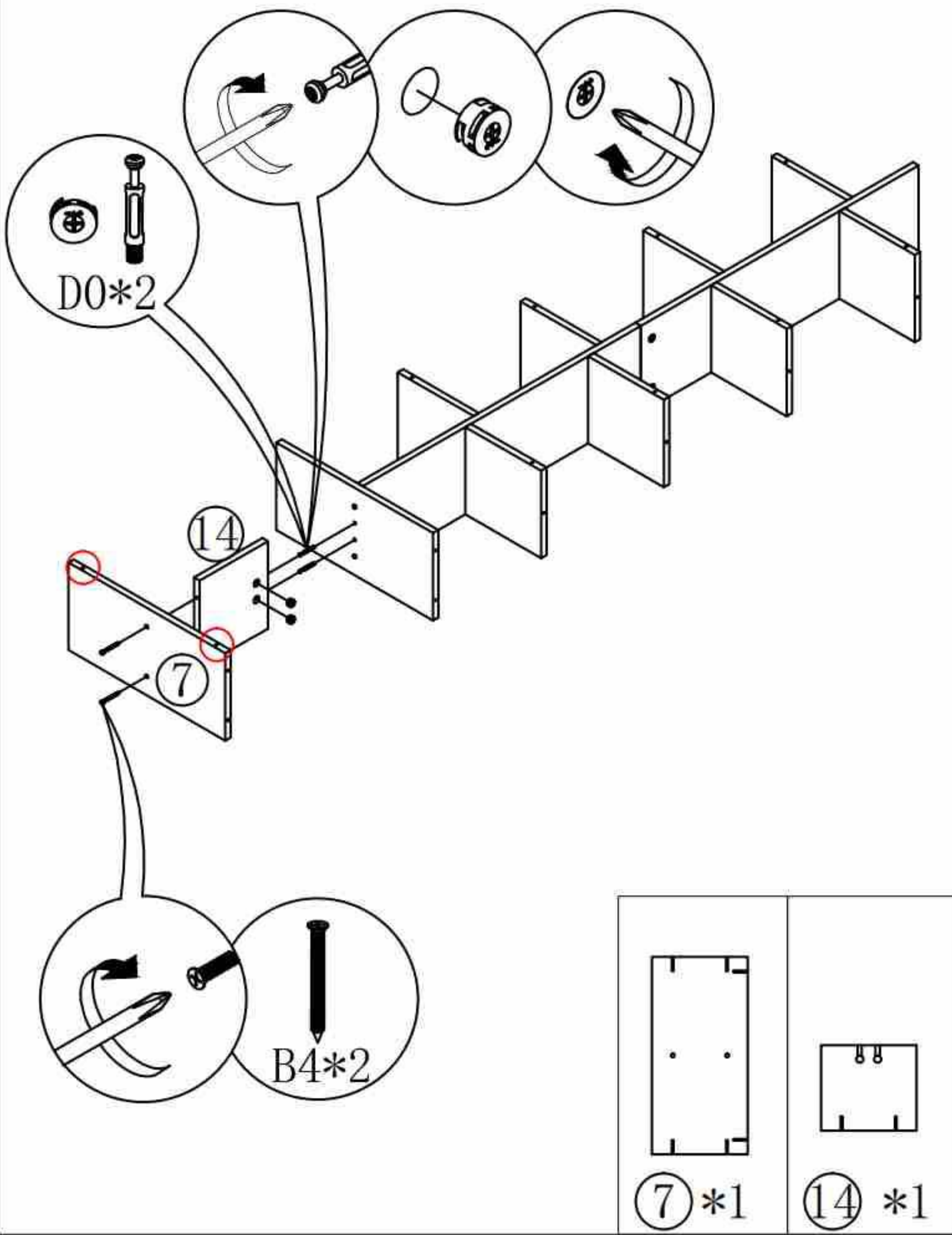

5,

Pay Attention To Circle The Location Of The Small Hole

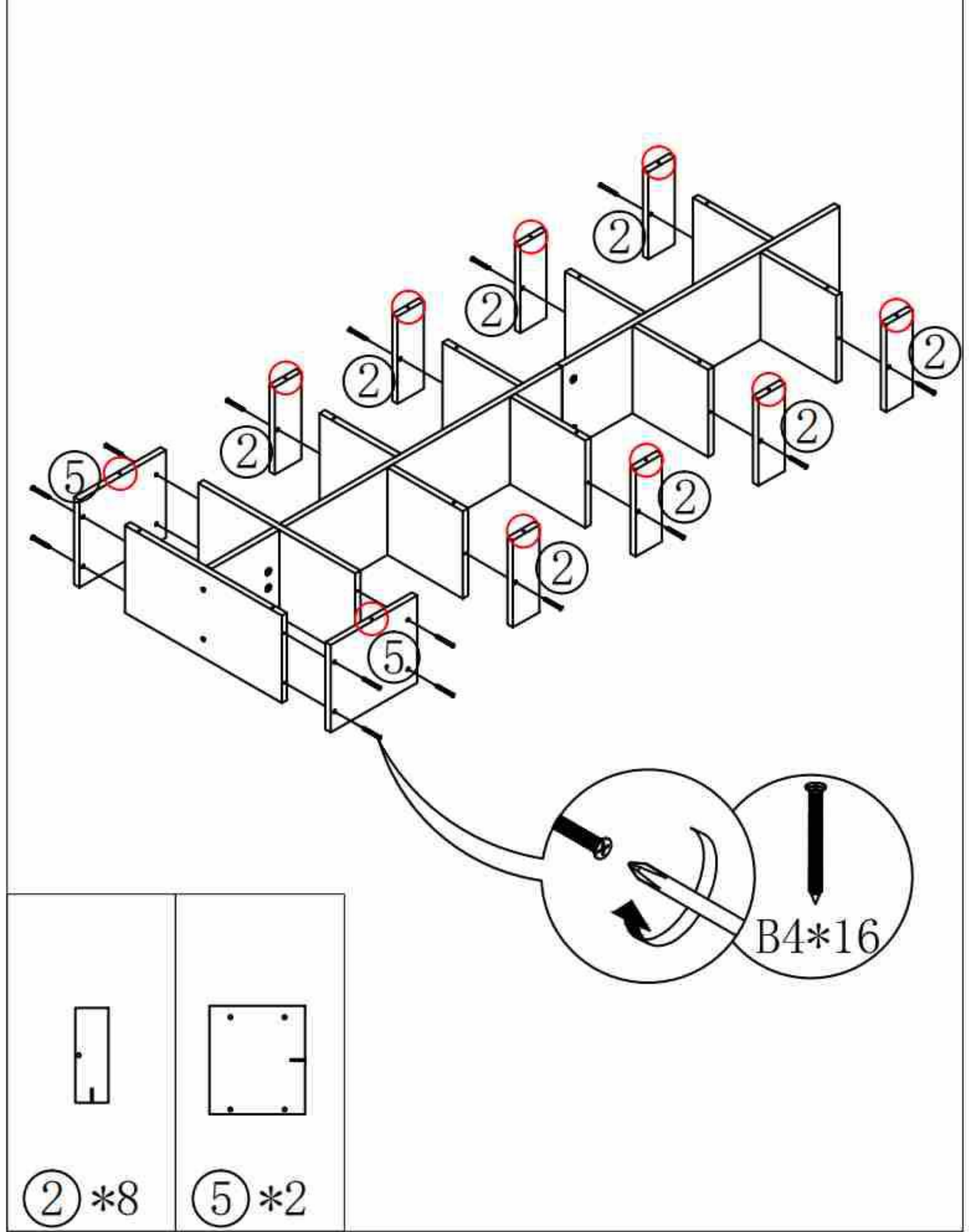

6,

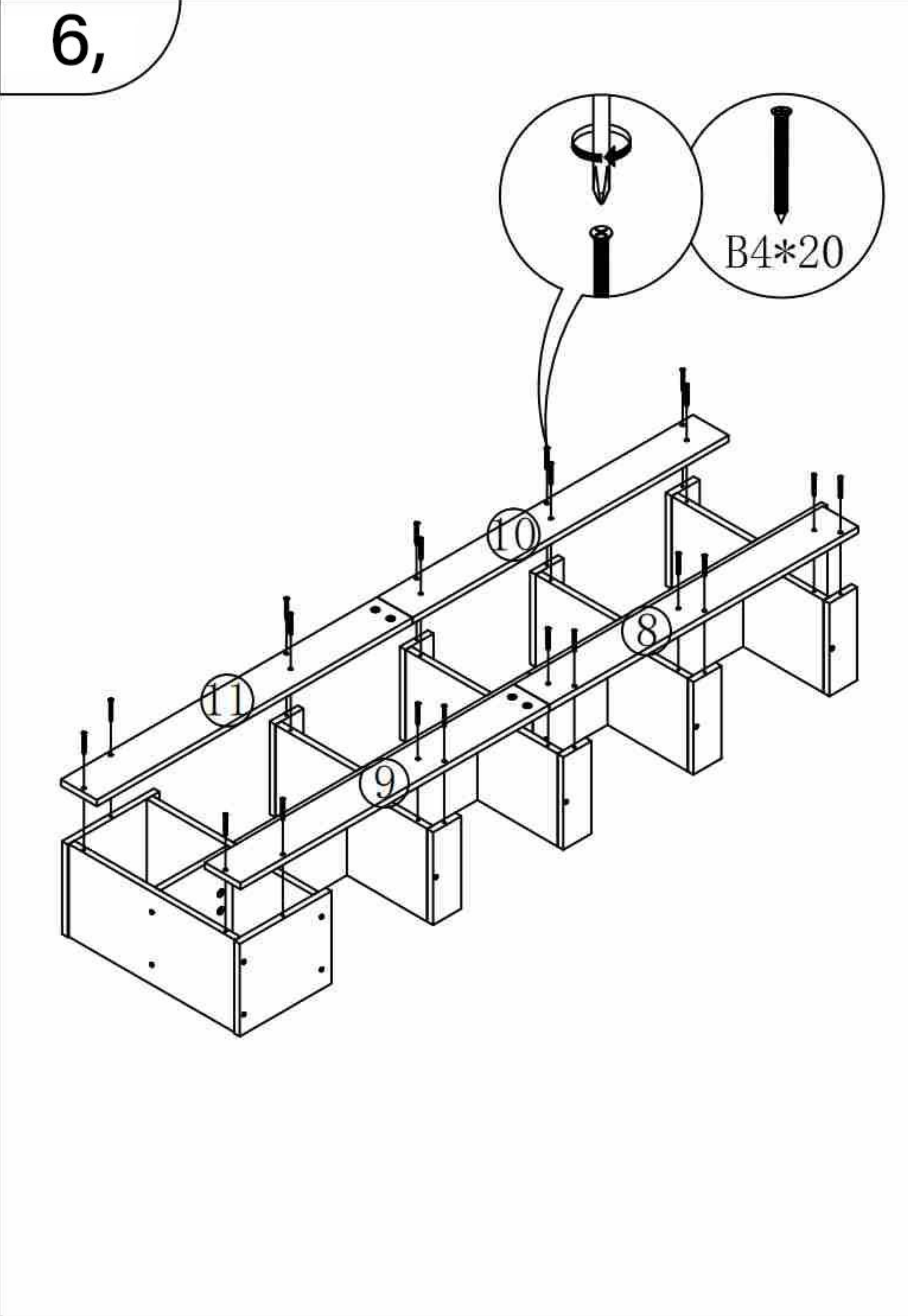

7,

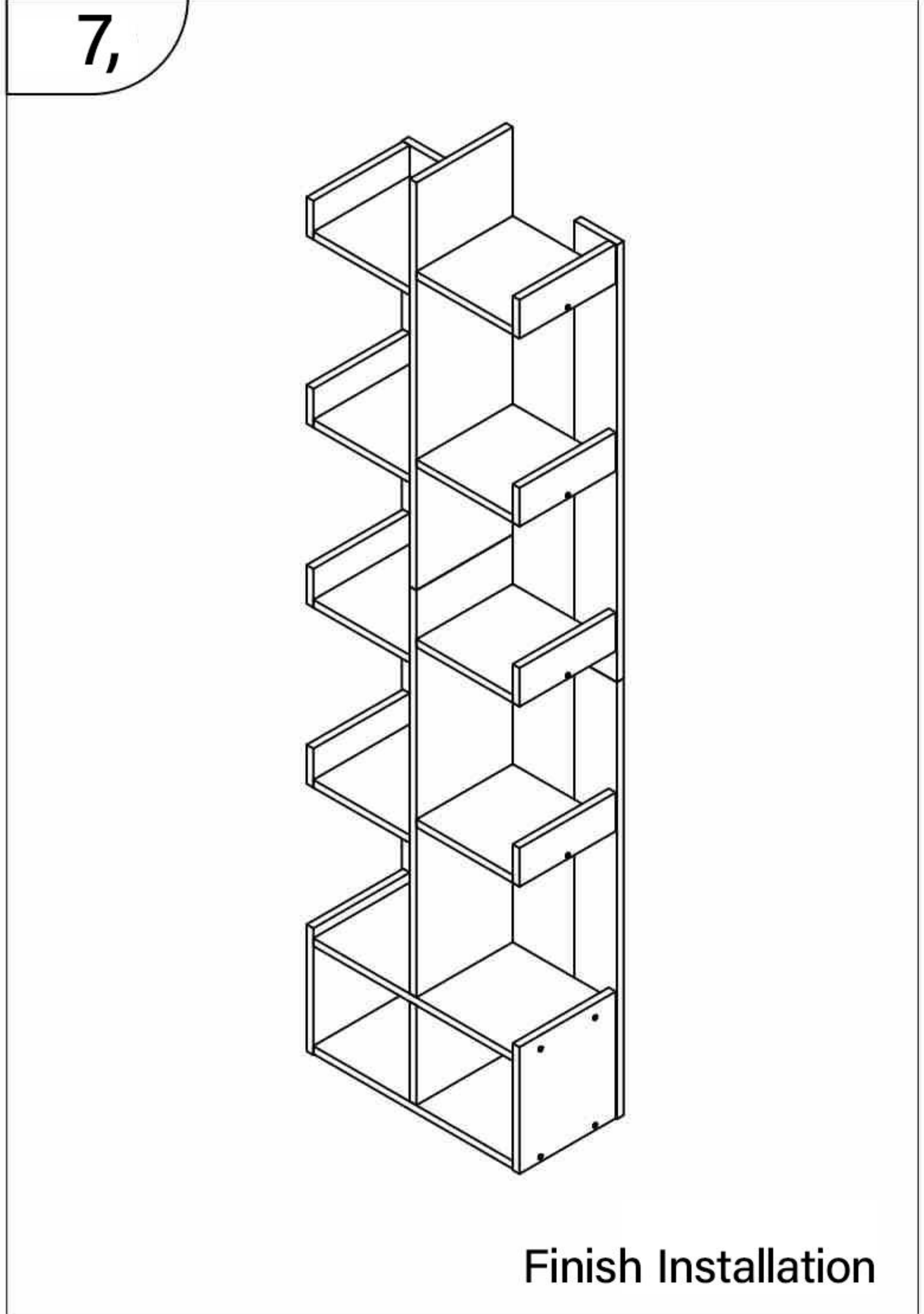

Finish Installation

